









Monostar HL-160/190 E20

KENMERKEN / FEATURES / MARKMALE

	HL-160 E20	HL-190 E20
H (max.)	± 15,70 m	± 18,60 m
A (max.)	± 13,70 m	± 16,60 m
C (min.)	± 2,10 m	± 2,36 m
DxF (min.)	4,07 x 1,85 m	4,07 x 1,85 m
ExF (max.)	6,07 x 1,85 m	6,07 x 1,85 m
H1	3,26 m	3,53 m
H2	2,45 m	2,72 m
H3	2,49 m	2,76 m
LxB	4,57 x 2,0 m	4,57 x 2,0 m
G	3,05 m	3,05 m
M	244 mm	244 mm
Ø D	± 4,03 m	± 4,03 m
Ø R	± 0,00 m	± 0,00 m
 (max.)	750 kg (2 pers. + 590kg)	550 kg (2 pers. + 390kg)
 (max.)	750 kg (2 pers. + 590kg)	550 kg (2 pers. + 390kg)
 (dec.)	52/43 sec.	62/53sec.
	3,6 km/h	3,6 km/h
	0,4 km/h	0,4 km/h
	33x12-20	33x12-20
 (max.)	± 25%	± 25%
	420 Ah/k5/48 V	420 Ah/k5/48 V
	7.760 kg	8.660 kg

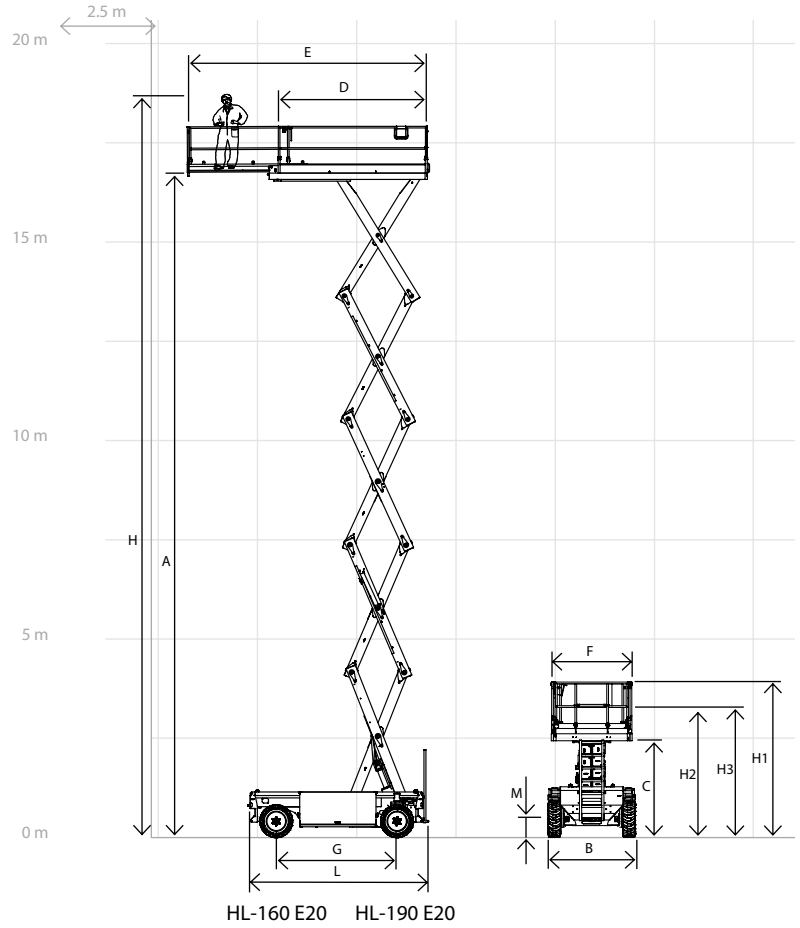

© 2015, Holland Lift International B.V. All rights reserved. Designs and specifications may change without prior notice. 140115

NEDERLANDS

ENGLISH

DEUTSCH

OPTIES

OPTIONS

OPTIONEN

Besturing met snelsluitstekker	Controlbox with quick disconnect	Plattformsteuerung mit Schnellstecker	<input checked="" type="checkbox"/>	<input checked="" type="checkbox"/>
Urenteller	Hourmeter	Stundenzähler	<input checked="" type="checkbox"/>	<input checked="" type="checkbox"/>
Lader (hoogfrequent)	Charger (high frequency)	Ladegerät (Hohghfrequenz)	<input checked="" type="checkbox"/>	<input checked="" type="checkbox"/>
230V voorziening op platform	230V supply on platform	230V Versorgung an der Plattform	<input type="checkbox"/>	<input type="checkbox"/>
Rijden op volle hoogte	Driving at full height	Fahren in voller Höhe	<input type="checkbox"/>	<input type="checkbox"/>
Rijden, proportioneel	Driving, proportional	Fahren, proportional	<input checked="" type="checkbox"/>	<input checked="" type="checkbox"/>
Sperfunctie	Differential lock	Differentialsperre	<input checked="" type="checkbox"/>	<input checked="" type="checkbox"/>
Smeersysteem (Easy Lube, Auto Lube)	Lubrication system (Easy Lube, Auto Lube)	Schmiersystem (Easy Lube, Auto Lube)	<input type="checkbox"/>	<input type="checkbox"/>

VEILIGHEIDSVORZIENINGEN

SAFETY FEATURES

SICHERHEITSEINRICHTUNGEN

Beschermhek	Scissor skirt	Schutzgitter	--	--
Daalbeveiliging	Descent safety	Senkschutz	<input checked="" type="checkbox"/>	<input checked="" type="checkbox"/>
Flitslampen	Flashing beacons	Blinkleuchten	<input checked="" type="checkbox"/>	<input checked="" type="checkbox"/>
Rij-alarm (akoestisch)	Drive alarm	Fahrwarnung (akustisch)	<input checked="" type="checkbox"/>	<input checked="" type="checkbox"/>
Nooddaalvoorziening	Emergency descent	Notsenkvorrichtung	<input checked="" type="checkbox"/>	<input checked="" type="checkbox"/>

TOEPASSING

APPLICATION

ANWENDUNG

Voor gebruik in gesloten ruimten	Indoors	In geschlossenen Räumen	<input checked="" type="checkbox"/>	<input checked="" type="checkbox"/>
Voor gebruik buiten	Outdoors	Im Freien	<input checked="" type="checkbox"/>	<input checked="" type="checkbox"/>
Toelaatbare min. omgevingstemperatuur	Certified min. temperature	Zul. Tiefsttemperatur	-15°C	-15°C